

GO

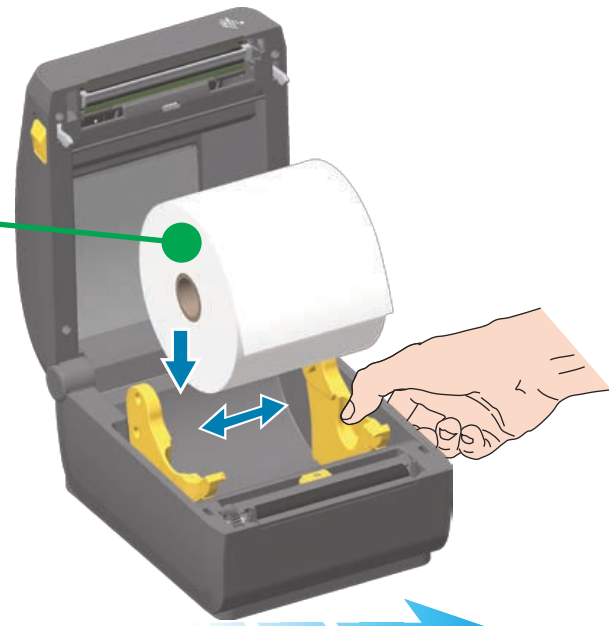

Remove and discard outer layer
Extraiga y deseche la capa externa
Retirez la pellicule de protection



Open and place roll on holder
Abra y coloque el rollo en el soporte
Ouvrez le rouleau et positionnez-le sur le support



Verify easy spin on holder
Verifique que gire fácilmente en el soporte
Contrôlez la mise en place rapide



Pull paper past printer front
Tire el papel hasta que salga más allá del frente de la impresora
Tirez le papier à l'avant de l'imprimante



Push the paper under guides
Empuje el papel debajo de las guías
Passez-le sous les guides

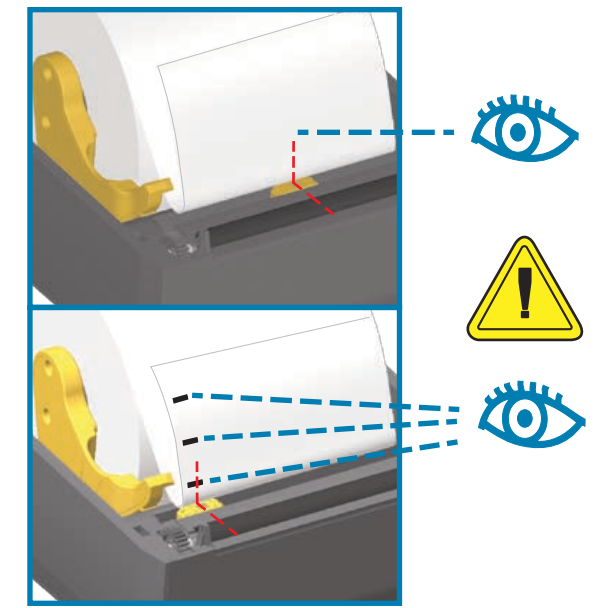

Align sensor near center (default) position or to middle of black marks.
Alinee el sensor cerca de la posición central (predeterminada) o en el medio de las marcas negras
Alignez la cellule sur la position centrale (valeur par défaut) ou sur le centre des marques noires

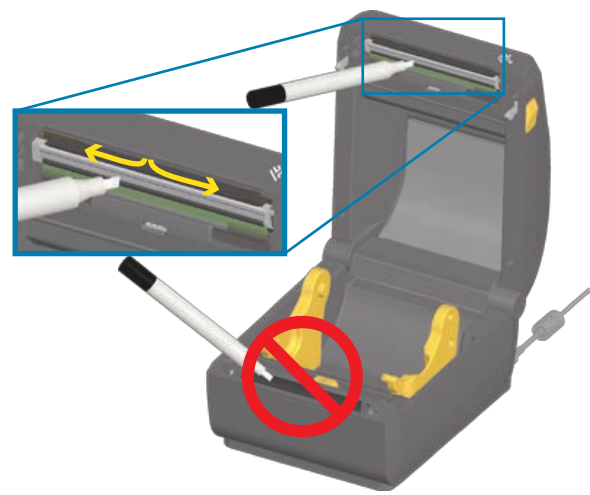

Clean printhead with cleaning pen
Wipe from middle to the outside edge
Limpie el cabezal de impresión con el lápiz de limpieza. Limpie desde el centro hacia el borde exterior.
Nettoyez la tête d'impression à l'aide du stylet de nettoyage. Procédez en allant du centre vers le bord extérieur.

Indicators - Indicateurs - Indicateurs					
STATUS	PAUSE	DATA	SUPPLIES	NETWORK	
					Ready Lista Prêt
					Paused En pausa En pause
					Cover Open Cubierta abierta Capot ouvert
					Media Out Sin papel Fin de papier
					Network Error Error de la red Erreur réseau
					Out of Memory Falta de memoria Mémoire saturée
					Printhead Overtemp Error Error cabezal de impresión muy caliente Erreur de tête d'impression en surchauffe

Pause
Pausa
Pause

Feed
Alimentación
Avance

Cancel
Cancelar
Annuler

Configuration Report
Informe de configuración
Rapport de configuration

Smart Calibration
Calibración inteligente
Calibrage intelligent

<http://www.zebra.com/contact>

<https://www.zebra.com/supplies>

www.zebra.com/zd420d-info



Close the printer
Cierre la impresora
Refermez l'imprimante

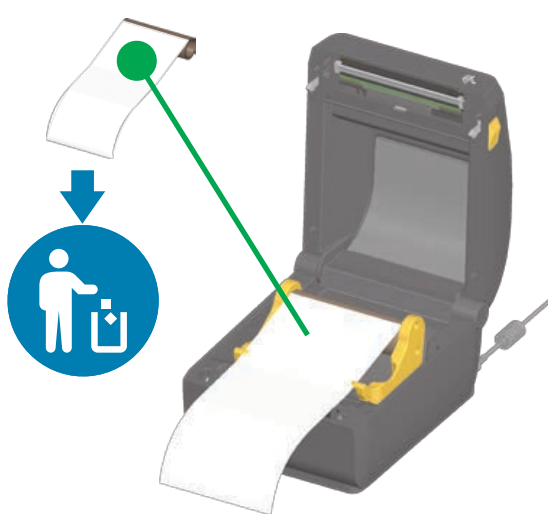

Open Printer
Discard empty roll
Abra la impresora
Deseche el rollo vacío
Ouvrez l'imprimante
Retirez le rouleau usagé

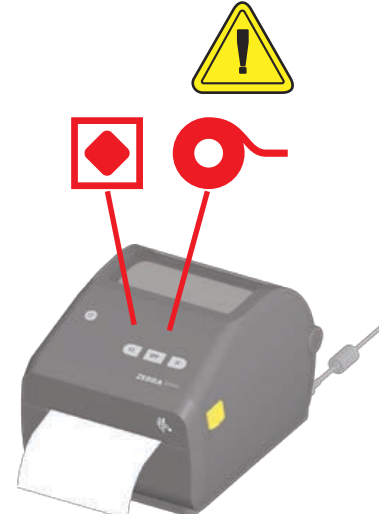

Media Out
Status + Media lights Red
Sin papel
Luces de estado + papel se encienden en color rojo
Fin de papier
Voyant rouge d'état et de support

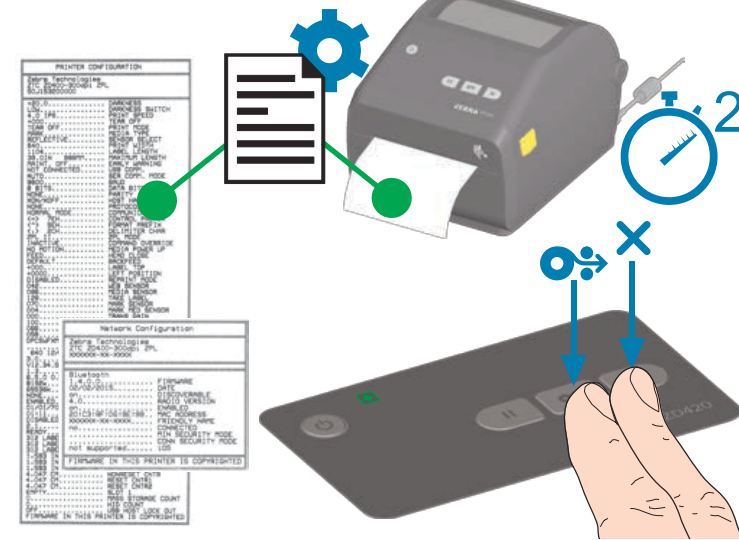

Press Feed + Cancel buttons for 2 seconds.
Prints Configuration Report.
Presione los botones Alimentación + Cancelar durante 2 segundos. Imprime el informe de configuración.
Appuyez sur les boutons Avance et Annuler pendant 2 secondes. Impression d'un rapport de configuration.

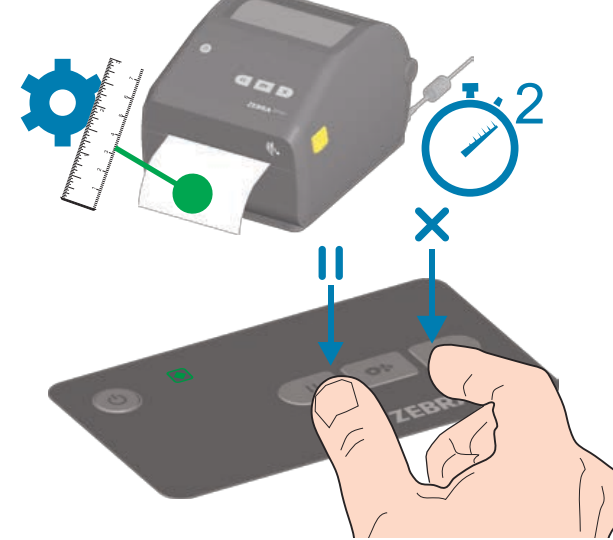

Press Pause + Cancel buttons for 2 seconds.
Performs Smart Calibration.
Presione los botones Pausa + Cancelar durante 2 segundos. Realiza la calibración inteligente
Appuyez sur les boutons Pause et Annuler pendant 2 secondes. Exécution du calibrage intelligent.

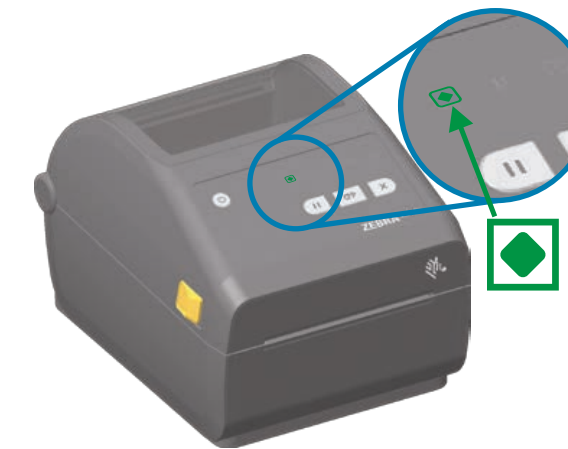

Green Status Light ON - Printer Ready
Luz de estado de color verde encendida: impresora lista
Voyant d'état vert allumé - Imprimante prête

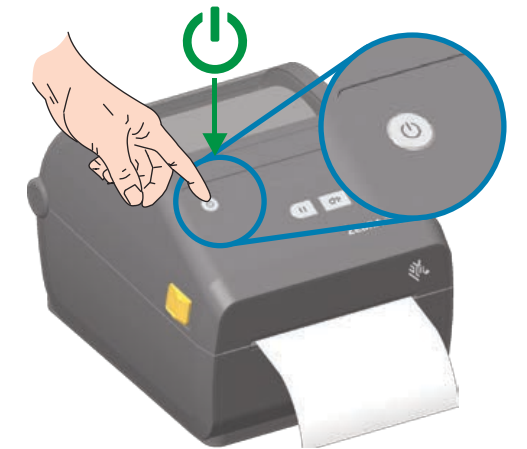

Press power and wait as lights cycle
Presione el botón de encendido y espere que las luces completen el ciclo de encendido y apagado
Appuyez sur le bouton Marche/Arrêt et attendez la fin du cycle d'initialisation



3 Learn About Genuine Zebra Supplies
<http://www.zebra.com/supplies>

2 Set Up Your Printer
<http://www.zebra.com/zd420-info>

1 Install Latest Zebra Setup Utilities
<http://www.zebra.com/setup>

ZD420

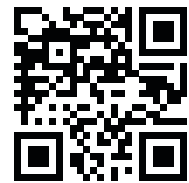

www.zebra.com/zd420-info

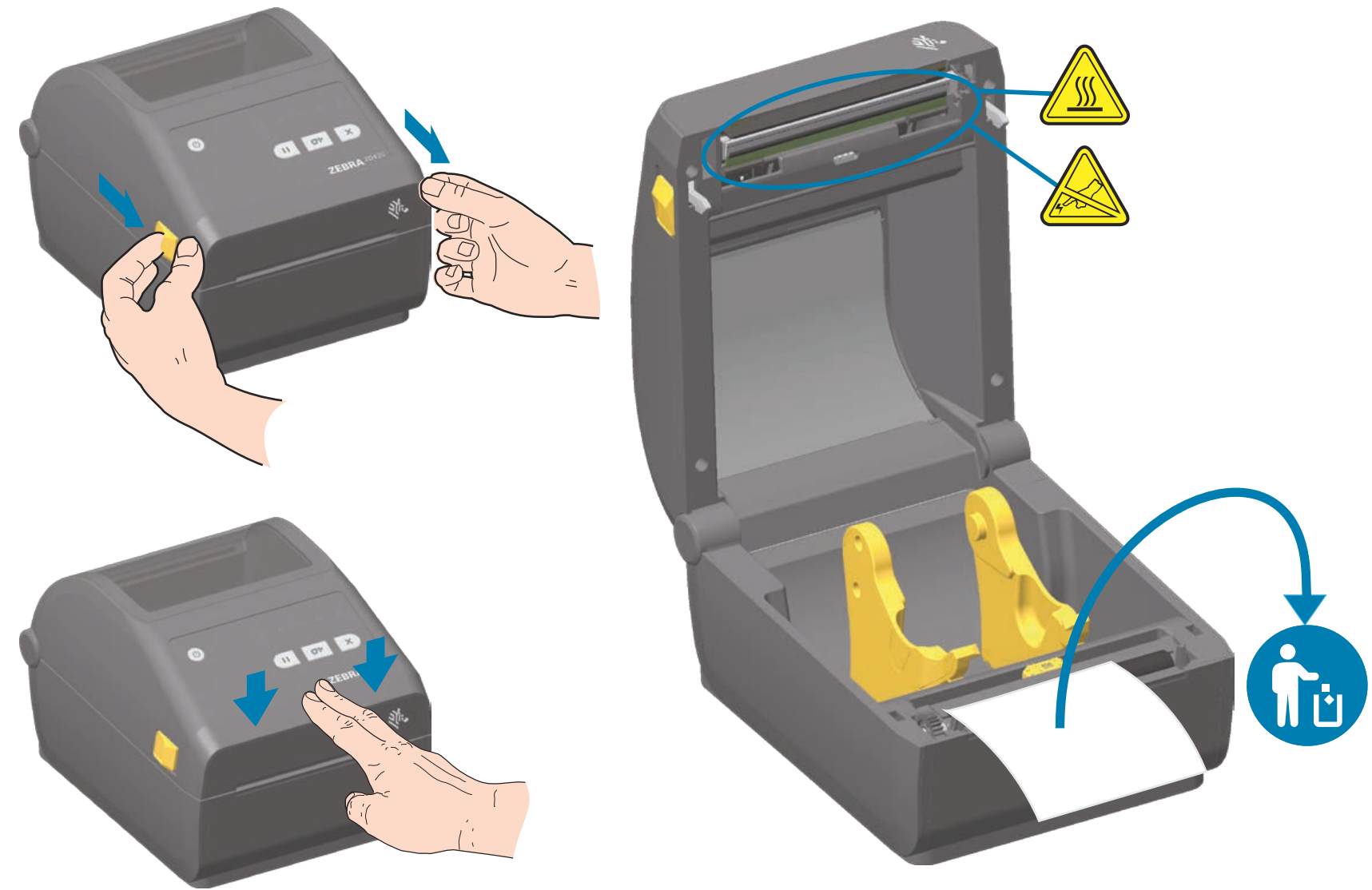

1 www.zebra.com/setup

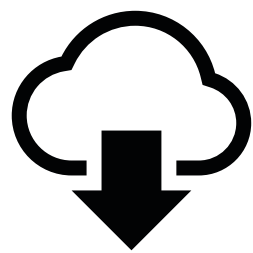

Download and Install Zebra Setup Utilities
 Includes Windows Printer Driver Files
 Descargue e instale Zebra Setup Utilities (Utilidades de configuración de Zebra). Incluye el controlador de impresora de Windows
 Téléchargez et installez Zebra Setup Utilities. (Pilote d'impression Windows inclus)

2

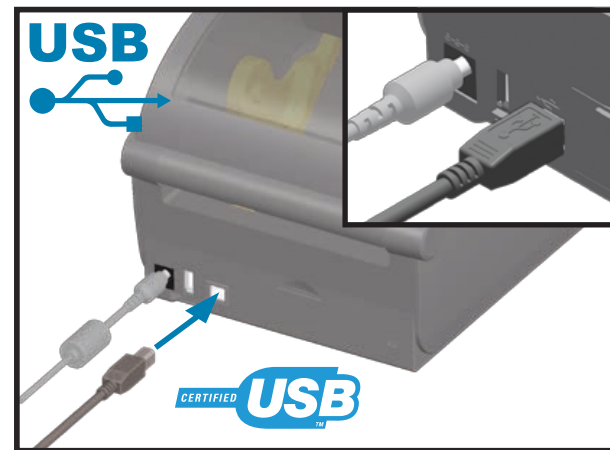

Connect a USB cable to the printer
 Conecte un cable USB a la impresora
 Branchez un câble USB à l'imprimante.

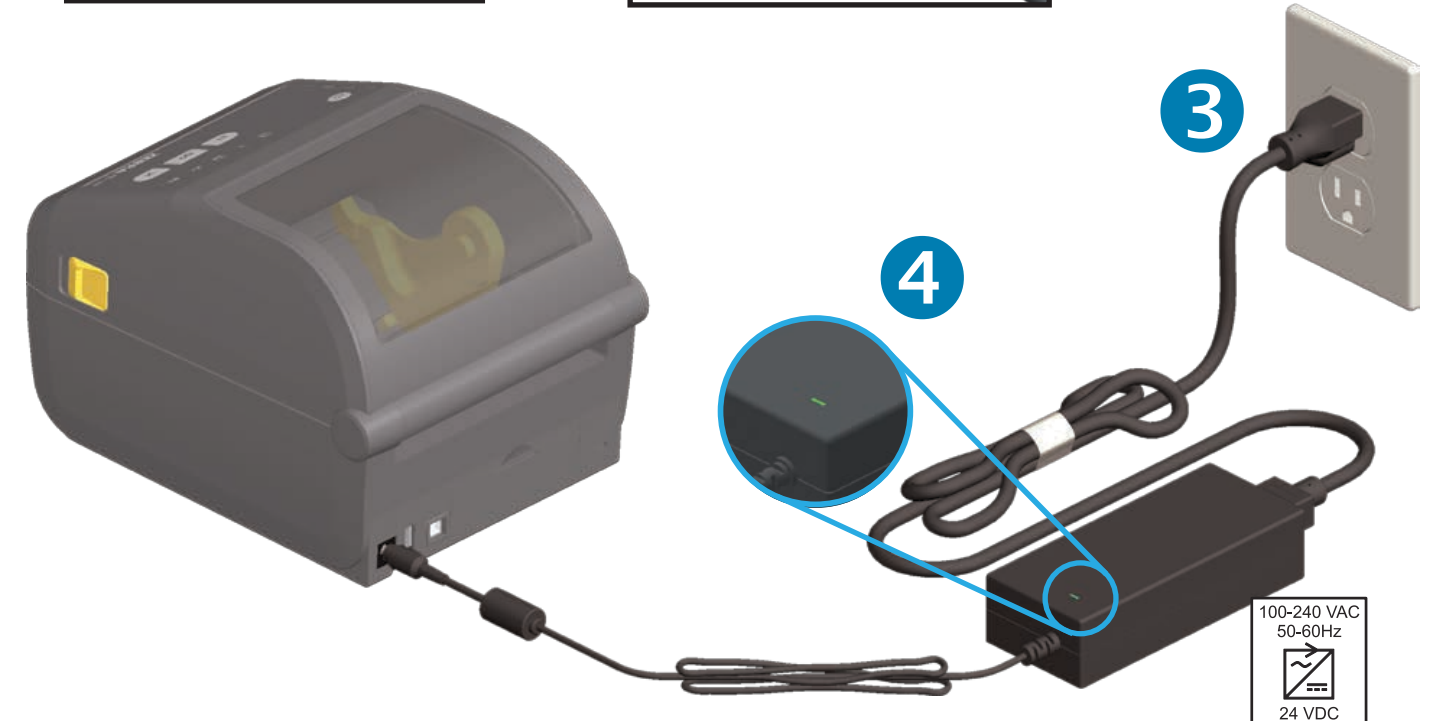
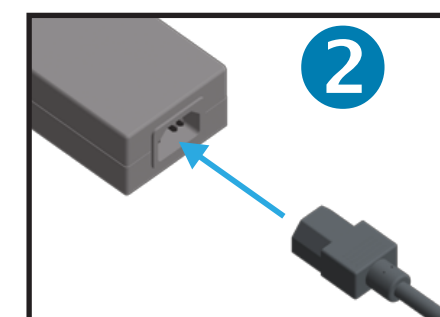
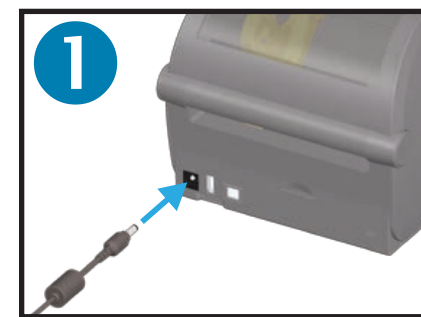

NA and Corporate Headquarters
 +1 800 423 0442
 inquiry4@zebra.com

Asia-Pacific Headquarters
 +65 6858 0722
 contact.apac@zebra.com

EMEA Headquarters
 zebra.com/locations
 mseurope@zebra.com

Latin America Headquarters
 +1 847 955 2283
 la.contactme@zebra.com

<http://www.zebra.com/locations>

©2017 ZIH Corp. and/or its affiliates. All rights reserved. Zebra and the stylized Zebra head are trademarks of ZIH Corp., registered in many jurisdictions worldwide. All other trademarks are the property of their respective owners.

Printed In China



212396-101

